

E-Lumen Compact
UNDERWATER LIGHT OPERATING MANUAL

Model: ELCOMP-N ELCOMP
Keep this manual for future reference

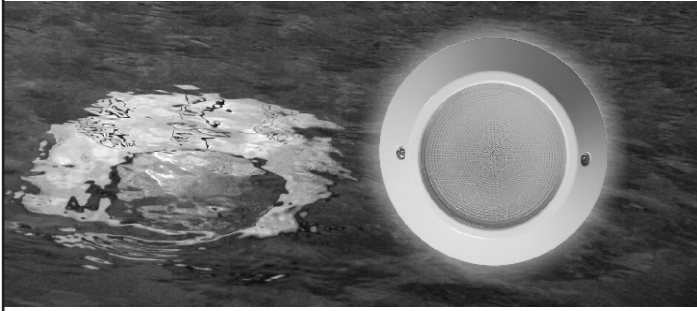

SAFETY WARNINGS

- Only qualified electrician is allowed to carry out the installation of this product.
- Avoid direct contact with electrical power.
- Understand all regulations in effect for preventing accidents.
- Switch off power to transformer before repairing or replacing the light.
- Never handle with wet hands and feet.
- This unit is design for use only when fully submerged in water, please use with suitable transformer.
- Never operate this Underwater Light for more than 1 minute unless it is totally submerged in water.
- This product should be installed according to your local electrical installation ordinances and regulations.
- Maximum Depth for Light installation at 1 meter.
- Maximum Water Temperature Range for light operation 0 - 30°C.

SPECIFICATION

- A. Electrical Specification : 1) Voltage : AC12V 2) Frequency : 50/60Hz
3) Power : 10W.
- B. Colour change options(For RGB version only)

4. For training or competition pools, the lights must be installed on the sides in order to prevent swimmers from seeing any glare.
5. Nothing should be placed on the poolside directly above the lights for ease of future maintenance.
6. Please ensure all wires and connections are sealed and waterproofed to avoid any damage.
7. The cables connecting the lights and the transformers must be at least 6mm² and the distance between them must not exceed 30m (Figure 2); otherwise the lights will not function properly.

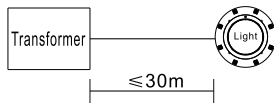

Figure 2

INSATALLATION OF THE UNDERWATER LIGHT

A. Preparing to Install

1. Before installation, a circuit system diagram must be designed by a certified engineer.
2. The circuit system must comply with local laws and regulations and must be carried out by qualified electricians.
3. Make sure the voltage is 12V and the terminal box is at least 120cm from the poolside (Figure 3).
4. Upon installation, top of the light must be at least 45cm from water surface (Figure 3).

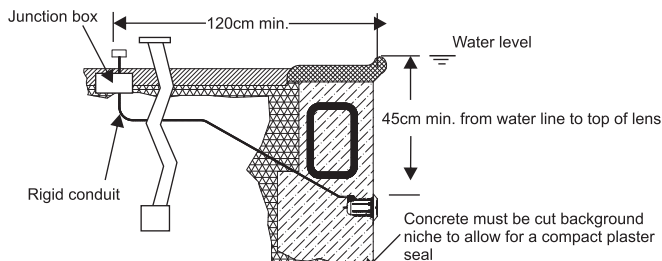

Figure 3

1	White
2	Green
3	Blue
4	Green+Blue
5	Red+Green
6	Red+Blue
7	Mode A: Blue+ Gradual Red
8	Mode B: Green+Gradual Red
9	Mode C: Blue+Gradual Green
10	Mode D: Blue+Gradual Red
11	Mode E: RGB Colour Sequence: Red>Green>Blue
12	Auto Colour Change
13	Mode F: Four Colour Sequence: Red>Green>Blue>Purple
14	Rapid Auto Colour Change

CONTROL

1. When the light is connected to the transformer directly, the on/off switch controls the colour changes (a light with a transformer with an on/off switch is recommended; If you want all the lights to change colour at the same time, please install a master switch, Figure 1).
2. If applicable, when the light is connected to the transformer and the transformer to the optional control box, the control panel on the control box and its remote control controls the colour changes (See the Control Box Manual for details).

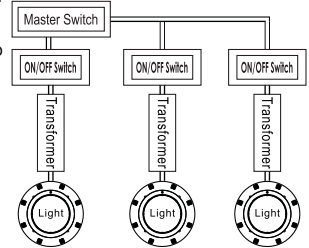

Figure 1

INSTALLATION NOTES

1. Each cable have 2.5m long. Please follow the procedures when installing the light.
2. It is recommended to install a light in every 4m², the approximate exposure area of each unit.
3. The lights should be installed in the direction that they will not shine directly into the house.

B. Pool Installation

1. Embed the Shell into the concrete wall, making sure that it is parallel to the side of the pool (Figure 4).
2. Place the Mounting Plate on the concrete wall and tighten it with 6 screws. (Figure 5).
3. Note that the light must only be installed on a flat or concave surface.
4. Wrap extra cables behind the light to make sure it could be taken to the pool surface for future maintenance .Then tighten the nut or line pipe joint (Figure 6).
5. Hang the light onto the Mounting ring and tighten the screws (Figure 7).
6. The wire connections inside the terminal box must be sealed by leak-proof tapes to prevent water from leaking into the terminal box through the cables.

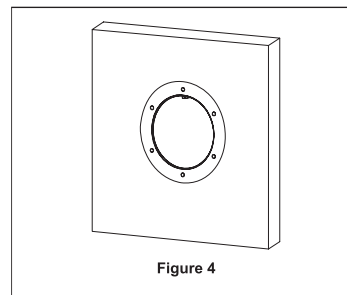

Figure 4

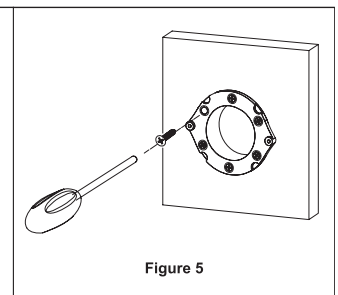

Figure 5

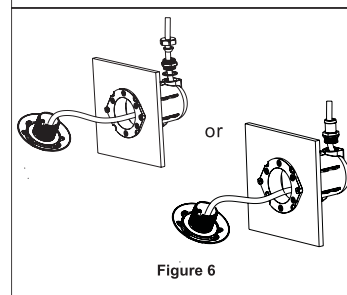

Figure 6

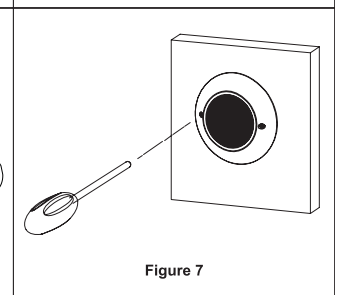

Figure 7

C. Fiberglass Pools / Vinyl Pools Installation

1. Refer to section "Preparing to Install".
2. Drill holes on the pool wall (Figure 8 and Figure 12).
3. Place the o-rings between the Mounting ring and the pool wall and tighten it with the Nut on the other side of the pool wall (Figure 9).
4. The lamp is arranged on the cover shell and through the line hole; then tighten the Nut (Figure 10 and Figure 13).
5. Wrap extra cables behind the light to make sure it could be taken to the pool surface for future maintenance. Then, hang the light onto the Mounting ring and tighten the screws (Figure 11 and Figure 14).

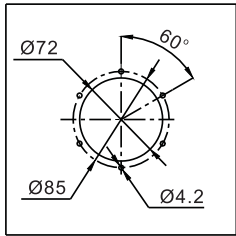

Figure 8

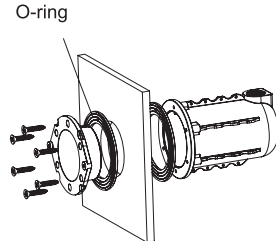

Figure 9

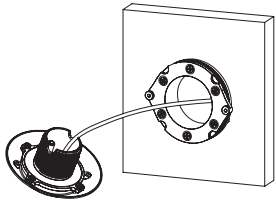

Figure 10

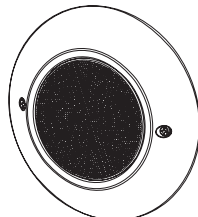

Figure 11

8-5

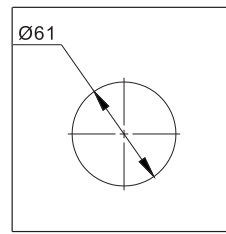

Figure 12

O-ring

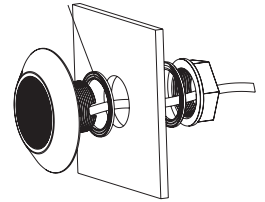

Figure 13

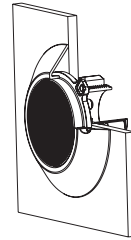

Figure 14

Maintenance of the Lights

- Do not leave the lights "on" without water for longer than 1 minute.
- Do not leave the lights directly under sunlight. Fill the pool with fresh water as soon as possible after the lights are installed.
- Before switching on the lights, check whether the lights are fully submerged underwater and the circuit boxes are running properly.
- This unit does not need any kind of maintenance. If it is not working properly, please contact EMAUX authorized dealer where you purchase the unit from.
- Warranty will be voided if the Emaux Underwater Light was dismantled by unauthorized personnel.

8-6

REPLACEMENT PARTS

Item	Part No.	Description English	Qty
1	03011338	M4*12 round head machine screw	2
2-1	01050126	Cover	1
2-2	01050134	Cover	1
3-1	04011116	Cool White Light	1
	04011117	RGB Light	
	04011118	Warm White Light	
	04011119	Single Blue Light	
3-2	04011137	Cool White Light	1
	04011138	RGB Light	
	04011139	Warm White Light	
	04011140	Single Blue Light	
4	03011354	M4*8 round head machine screw	4
5	03011160	M4*25 pan head tapping screw (Vinyl Pool)	6
	03011341	M4*16 pan head tapping screw (Concrete Pool)	6
6	01173036	Mounting ring	1
7	02021089	Rubber ring	2
8	01050133	Shell	1
9	89041604	Waterproof Fittings for cable	1
10	01051141	Hexagon nut	1
11	01171106	Line pipe joint	1
12	02021091	Rubber ring	2

8-7

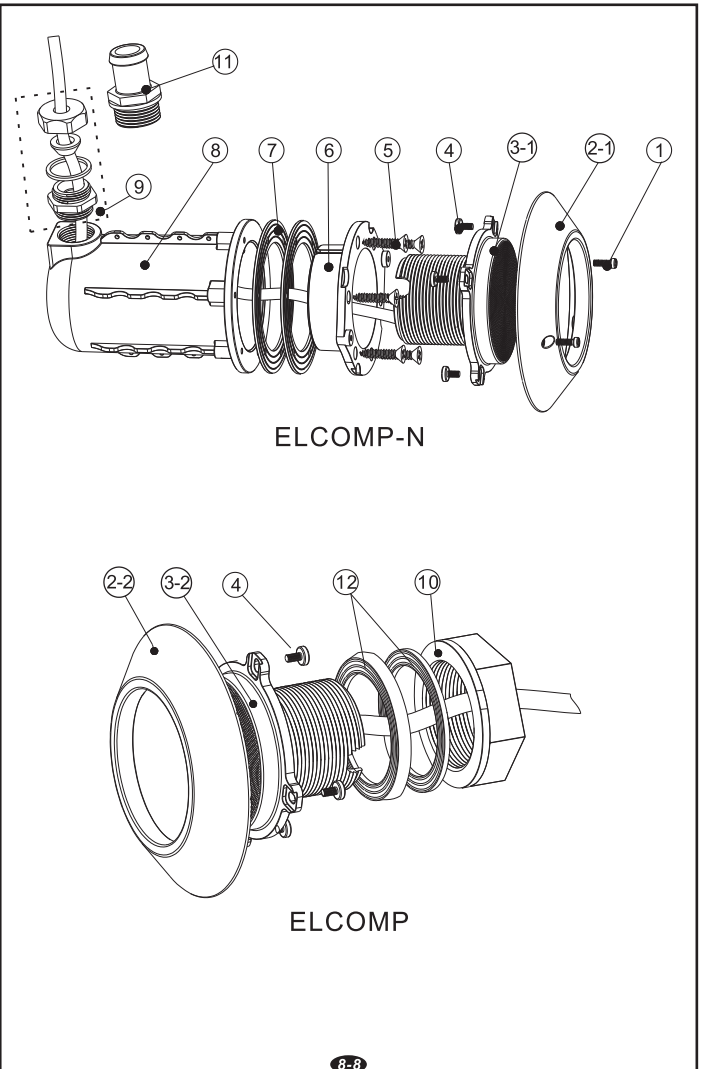

ELCOMP-N

ELCOMP

8-8